

Wire Management Products

Cord and Cable Reels

Industrial Power Cord Reels

HUBBELL

Features

- Durable, Corrosion Resistant Cast Aluminum Construction
- UL Type 1
- Multi-Position Guide Arm can be mounted in two different positions
- Positive Latch mechanism automatically maintains desired cord length
- Ratchet Lock can be disengaged in field for constant tension applications

Ordering Information

Description	UPC	Catalog Number
White Industrial Reel with Yellow Portable Outlet Box, GFCI Module and (1) 20A Duplex Receptacle, UL Type 1, 25 Ft, #12/3 SJO, 20 A, 250 VAC	783585586267	HBLI25123GF20

Listings

cULus Listed

Specifications

Spool	Aluminum
Guide Frame	Thermoplastic
Cord	Copper
Internal Terminals	Copper Alloy
Ball Stopper	Thermoplastic
Fitting	Aluminum

Performance

Electrical	
Amperage	20 A
Max. Working Voltage	250V AC
Number of Wires	3-Wire

Environmental

Moisture Resistance	Dry, Indoor, Non-Hazardous Locations - UL Type 1
---------------------	--

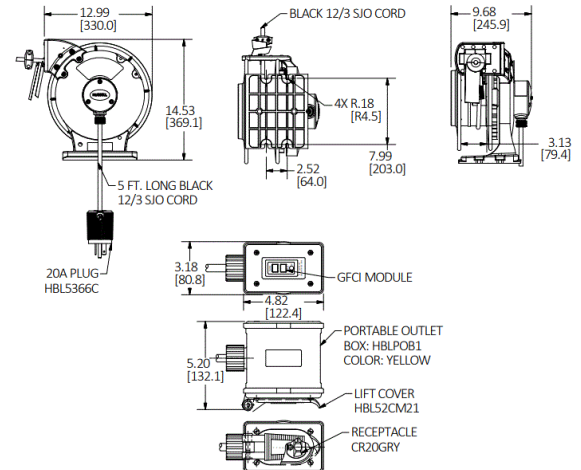

Complementary Products

Pivot Base	HBLI340PB
Mounting Bracket	HBLIMB
Ball Stop	HBLI12BS

Online Resources

Customer Sales Drawing
eCatalog
Installation Instructions

Dimensions in Inches (mm)

Hubbell Wiring Device-Kellems • Hubbell Incorporated (Delaware) • 40 Waterview Drive • Shelton, CT 06484

Phone (800) 288-6000 • Fax (800) 255-1031 • Specifications subject to change without notice.

