

## Wire Management Products

### Cord and Cable Reels

## Weatherproof Cord Reels

# HUBBELL

### Features

- Durable, Corrosion Resistant Cast Aluminum Construction
- UL Type 4
- Multi-Position Guide Arm can be mounted in two different positions
- Positive Latch mechanism automatically maintains desired cord length
- Ratchet Lock can be disengaged in field for constant tension applications



### Ordering Information

Description	UPC	Catalog Number
White Weatherproof Reel, UL Type 4, 45 Ft, #12/3 SOW, 20 A, 600 VAC	783585585970	HBLW45123W

### Listings

cULus Listed

### Specifications

Spool	Aluminum
Guide Frame	Thermoplastic
Cord	Copper
Internal Terminals	Copper Alloy
Ball Stopper	Thermoplastic
Fitting	Aluminum

### Performance

<b>Electrical</b>	
Amperage	20 A
Max. Working Voltage	600V AC
Number of Wires	3-Wire

### Environmental

Moisture Resistance	Dry, Indoor and Wet and Damp Outdoor, Non-Hazardous Locations - UL Type 4
---------------------	---

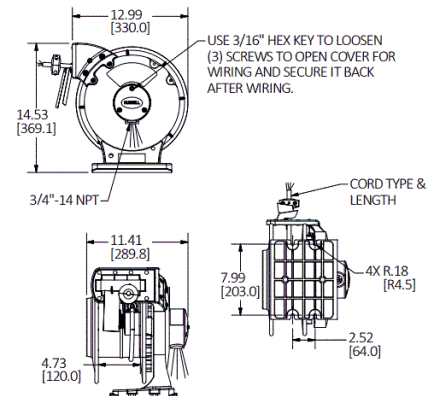

### Complementary Products

Pivot Base	HBLI340PB
Mounting Bracket	HBLIMB
Ball Stop	HBLI14BS

### Online Resources

Customer Sales Drawing  
eCatalog  
Installation Instructions

Dimensions in Inches (mm)

Hubbell Wiring Device-Kellems • Hubbell Incorporated (Delaware) • 40 Waterview Drive • Shelton, CT 06484

Phone (800) 288-6000 • Fax (800) 255-1031 • Specifications subject to change without notice.

