

## Wire Management Products

### Cord and Cable Reels

## Industrial Power Cord Reels

# HUBBELL

### Features

- Durable, Corrosion Resistant Cast Aluminum Construction
- UL Type 1
- Multi-Position Guide Arm can be mounted in two different positions
- Positive Latch mechanism automatically maintains desired cord length
- Ratchet Lock can be disengaged in field for constant tension applications

### Ordering Information

Description	UPC	Catalog Number
Yellow Industrial Reel with Black Portable Outlet Box, GFCI Module and (2) 15A Duplex Receptacles, UL Type 1, 35 Ft, #14/3 SJO, 15 A, 250 VAC	783585585277	HBLI35143GF215M 1Y

### Listings

cULus Listed

### Specifications

Spool	Aluminum
Guide Frame	Thermoplastic
Cord	Copper
Internal Terminals	Copper Alloy
Ball Stopper	Thermoplastic
Fitting	Aluminum

### Performance

<b>Electrical</b>	
Amperage	15 A
Max. Working Voltage	250V AC
Number of Wires	3-Wire

### Environmental

Moisture Resistance	Dry, Indoor, Non-Hazardous Locations - UL Type 1
---------------------	--

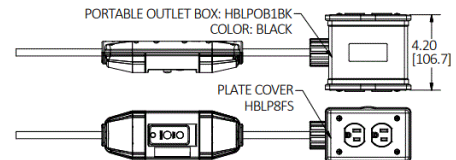
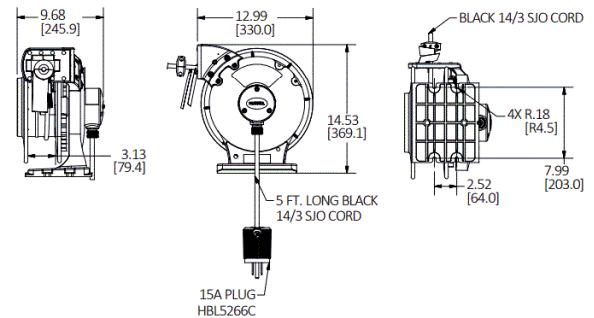

### Complementary Products

Pivot Base	HBLI340PB
Mounting Bracket	HBLIMB
Ball Stop	HBLI16BS

### Online Resources

Customer Sales Drawing  
eCatalog  
Installation Instructions

Dimensions in Inches (mm)

Hubbell Wiring Device-Kellems • Hubbell Incorporated (Delaware) • 40 Waterview Drive • Shelton, CT 06484

Phone (800) 288-6000 • Fax (800) 255-1031 • Specifications subject to change without notice.

