

# UCX Bearing Inserts

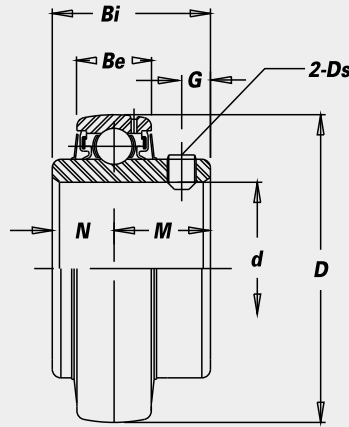

## Medium duty with set screw lock.

- Wide inner race with greater load carrying capacity than UC insert
- B-type seals  
L3-type seals available in some sizes



STANDARD PRODUCTS

Bearing No.	Bore Dia. of Bearing		Dimensions (in. (mm))							Basic Load Rating (lbs.)	Basic Static Load Rating (lbs.)	Weight (lbs.)
	<i>d</i>	<i>d</i>	<i>D</i>	<i>Bi</i>	<i>Be</i>	<i>N</i>	<i>M</i>	<i>G</i>	<i>Ds</i>			
UC X05-14	7/8	25	2.4409	1.5000	0.7480	0.6260	0.8740	0.2362	1/4-28UNF	4,200	2,430	0.93
X05-15	15/16											0.89
X05	1											0.86
X05-16	1											0.84
UC X06-18	1 1/8	30	2.8346	1.6890	0.7874	0.6890	1.0000	0.2559	5/16-24UNF	5,535	3,340	1.35
X06	1 1/8											1.28
X06-19	1 3/16											1.28
X06-20	1 1/4											1.21
UC X07-22	1 3/8	35	3.1496	1.9370	0.8268	0.7480	1.1890	0.3150	5/16-24UNF	6,375	3,960	1.65
X07	1 3/8											1.65
X07-23	1 7/16											1.59
UC X08-24	1 1/2	40	3.3465	1.9370	0.8661	0.7480	1.1890	0.3150	5/16-24UNF	7,110	4,460	1.92
X08	1 1/2											1.83
UC X09-26	1 5/8	45	3.5433	2.0315	0.9449	0.7480	1.2835	0.3543	3/8-24UNF	7,400	4,910	2.36
X09-27	1 11/16											2.23
X09-28	1 3/4											2.14
X09	1 3/4											2.09
UC X10-30	1 7/8	50	3.9370	2.1890	0.9843	0.8740	1.3150	0.3543	3/8-24UNF	9,490	6,440	3.00
X10-31	1 15/16											2.91
X10	2											2.84
X10-32	2											2.78
UC X11-34	2 1/8	55	4.3307	2.5630	1.0630	1.0000	1.5630	0.4134	3/8-24UNF	11,500	7,940	4.12
X11	2 1/8											3.97
X11-35	2 3/16											3.92
X11-36	2 1/4											3.75
UC X12	2 3/8	60	4.7244	2.5630	1.1024	1.0000	1.5630	0.4724	1/2-20UNF	12,400	8,760	4.52
X12-38	2 3/8											4.48
X12-39	2 7/16											4.30
UC X13-40	2 1/2	65	4.9213	2.9370	1.1811	1.1890	1.7480	0.4724	1/2-20UNF	13,530	9,620	4.75
X13	2 1/2											4.56
UC X14-43	2 11/16	70	5.1181	3.0630	1.2598	1.3110	1.7520	0.4724	1/2-20UNF	14,620	10,540	6.06
X14	2 11/16											6.04
UC X15-47	2 15/16	75	5.5118	3.2520	1.2992	1.3110	1.9410	0.5512	1/2-20UNF	16,000	11,700	7.77
X15	2 15/16											7.52
X15-48	3											7.32
UC X17	3	85	6.2992	3.7795	1.4961	1.5630	2.2165	0.5906	1/2-20UNF	21,120	15,800	11.1
X17-55	3 7/16											10.7
X17-56	3 1/2											10.4
UC X20	3 15/16	100	7.4803	4.6260	1.6929	1.9370	2.6890	0.7087	5/8-18UNF	29,300	23,100	18.9
X20-63	3 15/16											18.6
X20-64	4											18.4