

UCPX Pillow Blocks



B-type Seal



L3-type Seal

Medium duty with set screw lock.

- Wide inner race bearing with greater load carrying capacity than standard duty
- Cast iron housing
- B-type seals
- L3-type seals available in some sizes

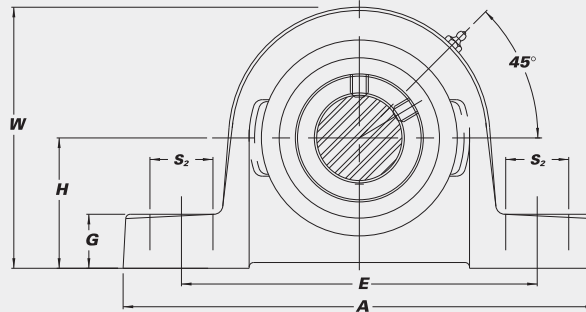
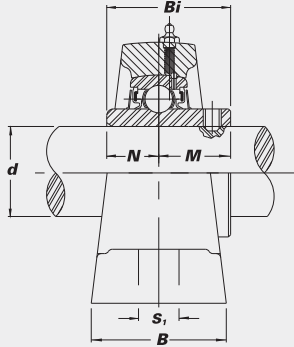
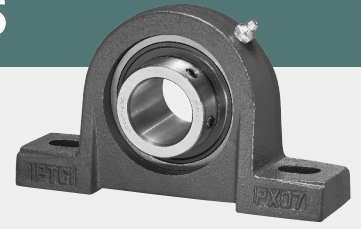

Unit No.	Shaft Dia.		Dimensions (in.) (mm)										Bolt Used	Bearing No.	Housing No.	Weight (lbs.)	
	d (in.)	d (mm)	H	A	E	B	S ₂	S ₁	G	W	Bi	N					M
UCP X05-14 X05-15 X05-16	7/8 15/16 1	25	1 11/16 42.9	6 5/16 160	4 3/4 121	1 3/4 44	1 3/16 21	9/16 14.2	1 1/16 18	3 19/64 83.7	1.5000 38.1	0.6260 15.9	0.8740 22.2	1/2	UC X05-14 X05-15 X05-16	P X05	3.5
UCP X06-18 X06-19 X06-20	1 1/8 1 3/16 1 1/4	30	1 7/8 47.6	6 17/32 165.9	5 127	1 29/32 48.5	7/8 22.4	9/16 14.2	3/4 19.1	3 11/16 93.7	1.6890 42.9	0.6890 17.5	1.0000 25.4	1/2	UC X06-18 X06-19 207-20	P 207	4.6
UCP X07-22 X07 X07-23	1 3/8 1 7/16	35	2 1/8 54.0	7 1/4 184.2	5 17/32 140.5	1 15/16 49.2	1 5/16 23.8	9/16 14.2	1 3/16 20.6	4 3/16 106.4	1.9370 49.2	0.7480 19.0	1.1890 30.2	1/2	UC X07-22 X07 X07-23	P X07	6.0
UCP X08-24 X08	1 1/2	40	2 1/8 54.0	7 1/2 190.5	5 3/4 146.1	2 1/8 54.1	1 13/16 20.6	1 9/32 15	7/8 22.3	4 17/64 108.3	1.9370 49.2	0.7480 19.0	1.1890 30.2	1/2	UC X08-24 X08	P 209	7.7
UCP X09-26 X09-27 X09-28 X09	1 5/8 1 11/16 1 3/4	45	2 1/4 57.2	8 203.2	6 1/4 158.8	2 1/4 57.2	1 5/16 23.8	2 3/32 18.3	1 5/16 23.8	4 33/64 114.7	2.0315 51.6	0.7480 19.0	1.2835 32.6	5/8	UC X09-26 X09-27 X09-28 X09	P 210	8.2
UCP X10-30 X10-31 X10 X10-32	1 7/8 1 15/16	50	2 1/2 63.5	8 5/8 219.2	6 7/8 174.8	2 3/8 60.5	1 5/16 23.8	2 3/32 18.3	1 1/16 26.9	5 1/32 127.8	2.1890 55.6	0.8740 22.2	1.3150 33.4	5/8	UC X10-30 X10-31 X10 211-32	P 211	10.1
UCP X11-34 X11 X11-35 X11-36	2 1/8 2 3/16 2 1/4	55	2 3/4 69.8	9 17/32 242.1	7 11/32 186.4	2 1/2 63.5	1 25.4	2 5/32 19.8	1 1/16 26.9	5 59/64 140.1	2.5630 65.1	1.0000 25.4	1.5630 39.7	5/8	UC X11-34 X11 X11-35 212-36	P 212	14.1
UCP X12 X12-38 X12-39	2 3/8 2 7/16	60	3 76.2	10 3/4 273.1	8 1/8 206.4	2 11/16 68.3	1 9/16 30.2	1 13/16 20.4	1 1/8 28.6	5 63/64 152	2.5630 65.1	1.0000 25.4	1.5630 39.7	5/8	UC X12 X12-38 X12-39	P X12	17.0
UCP X13-40 X13	2 1/2	65	3 76.2	10 3/4 273.1	8 1/8 206.4	2 11/16 68.3	1 9/16 30.2	1 13/16 20.4	1 1/8 28.6	5 63/64 152	2.9370 74.6	1.1890 30.2	1.7480 44.4	5/8	UC X13-40 X13	P X13	17.3
UCP X14-43 X14-44 X14	2 11/16 2 3/4	70	3 1/2 88.9	13 330	9 229	3 1/2 89	2 51	1 1/16 27	1 3/8 35	6 25/32 172	3.0630 77.8	1.3110 33.3	1.7520 44.5	7/8	UC X14-43 X14-44 X14	P X14	24.5
UCP X15 X15-47 X15-48	2 15/16 3	75	3 1/2 88.9	11 3/4 298.5	9 1/8 231.8	3 76.2	1 1/16 36.5	1 25.4	1 3/8 35	7 1/32 178.6	3.2520 82.6	1.3110 33.3	1.9410 49.3	7/8	UC X15 X15-47 X15-48	P X15	23.6
UCP X17 X17-55 X17-56	3 7/16 3 1/2	85	4 101.6	14 355.6	11 1/16 281	3 3/8 85.7	1 13/16 46	1 25.4	1 9/16 40	8 203.2	3.7795 96.0	1.5630 39.7	2.2165 56.3	7/8	UC X17 X17-55 X17-56	P X17	35.7
UCP X20 X20-63 X20-64	3 15/16 4	100	5 127.0	17 432	13 1/4 337	4 102	2 51	1.13 29	1 13/16 46	9 27/32 250	4.6260 117.5	1.9370 49.2	2.6890 68.3	1	UC X20 X20-63 X20-64	P X20	66.8

Interchange Page 47

STANDARD PRODUCTS