

BALDOR® • RELIANCE 

Product Information Packet

M3454

.25HP, 1725RPM, 3PH, 60HZ, 48, 3410M, TEFC, F1

Part Detail							
Revision:	S	Status:	PRD/A	Change #:		Proprietary:	No
Type:	AC	Elec. Spec:	34WG0895	CD Diagram:	CD0005	Mfg Plant:	
Mech. Spec:	34A051	Layout:	34LYA051	Poles:	04	Created Date:	
Base:	RG	Eff. Date:	02-15-2018	Leads:	9#18		

Specs			
Catalog Number:	M3454	Insulation Class:	B
Enclosure:	TEFC	Inverter Code:	Not Inverter
Frame:	48	KVA Code:	L
Frame Material:	Steel	Lifting Lugs:	No Lifting Lugs
Output @ Frequency:	.250 HP @ 60 HZ	Locked Bearing Indicator:	No Locked Bearing
Synchronous Speed @ Frequency:	1800 RPM @ 60 HZ	Motor Lead Quantity/Wire Size:	9 @ 18 AWG
Voltage @ Frequency:	460.0 V @ 60 HZ	Motor Lead Exit:	Ko Box
	230.0 V @ 60 HZ	Motor Lead Termination:	Flying Leads
XP Class and Group:	None	Motor Type:	3410M
XP Division:	Not Applicable	Mounting Arrangement:	F1
Agency Approvals:	CSA	Power Factor:	56
	UR	Product Family:	General Purpose
Auxillary Box:	No Auxillary Box	Pulley End Bearing Type:	Ball
Auxillary Box Lead Termination:	None	Pulley Face Code:	Standard
Base Indicator:	Rigid	Pulley Shaft Indicator:	Standard
Bearing Grease Type:	Polyrex EM (-20F +300F)	Rodent Screen:	None
Blower:	None	Shaft Extension Location:	Pulley End
Current @ Voltage:	.650 A @ 460.0 V	Shaft Ground Indicator:	No Shaft Grounding

	1.300 A @ 230.0 V	Shaft Rotation:	Reversible
	1.700 A @ 208.0 V	Shaft Slinger Indicator:	No Slinger
Design Code:	B	Speed Code:	Single Speed
Drip Cover:	No Drip Cover	Motor Standards:	NEMA
Duty Rating:	CONT	Starting Method:	Direct on line
Electrically Isolated Bearing:	Not Electrically Isolated	Thermal Device - Bearing:	NONE (OLD)
Feedback Device:	NO FEEDBACK	Thermal Device - Winding:	None
Front Face Code:	Standard	Vibration Sensor Indicator:	No Vibration Sensor
Front Shaft Indicator:	None	Winding Thermal 1:	None
Heater Indicator:	No Heater	Winding Thermal 2:	None

Nameplate NP1256L										
CAT.NO.	M3454									
SPEC.	34A51-895									
HP	.25									
VOLTS	230/460									
AMP	1.3/.65									
RPM	1725									
FRAME	48				HZ	60			PH	3
SER.F.	1.35			CODE	L	DES	B		CLASS	B
NEMA-NOM-EFF	64			PF	56					
RATING	40C AMB-CONT									
CC									USABLE AT 208V	1.7
DE	6203				ODE	6203				
ENCL	TEFC			SN						
	SFA 1.6/.8									

Parts List		
Part Number	Description	Quantity
SA009759	SA 34A51-895	1.000 EA
RA006204	RA 34A51-895	1.000 EA
NS2512A01	INSULATOR, CONDUIT BOX X	1.000 EA
34CB3002A	CB CAST W/.88 DIA HOLE	1.000 EA
34GS1029A01	GASKET, CONDUIT BOX	1.000 EA
51XB1016A07	10-16 X 7/16 HXWSSLD SERTYB	2.000 EA
11XW1032G06	10-32 X .38, TAPTITE II, HEX WSHR SLTD U	1.000 EA
34EP3102A01SP	FR ENDPLATE, MACH	1.000 EA
HW5100A03	WAVY WASHER (W1543-017)	1.000 EA
34EP3102A02SP	FR/PU ENDPLATE, MACH	1.000 EA
XY1032A02	10-32 HEX NUT DIRECTIONAL SERRATION	4.000 EA
34FN3002A01SP	EXTERNAL FAN, PLASTIC, .637/.639 HUB W/	1.000 EA
34FH4002A01SP	IEC FH NO GREASER PRIMED	1.000 EA
51XW1032A06	10-32 X .38, TAPTITE II, HEX WSHR SLTD S	3.000 EA
34CB4517	CB LID 4 MTG HOLES .22 DIA STAMPED, FOR	1.000 EA
34GS1031A01	GASKET, FLAT CONDUIT BOX LID (LEXIDE)	1.000 EA
51XW0832A07	8-32 X .44, TAPTITE II, HEX WSHR SLTD SE	4.000 EA
MG1000G27	MED CHARCOAL METALLIC GREY 400-0096	0.014 GA
85XU0407S04	4X1/4 U DRIVE PIN STAINLESS	2.000 EA
HA3100A12	THRUBOLT 10-32 X 7.375	4.000 EA
LC0005E01	CONN.DIA./WARNING LABEL (LC0005/LB1119N)	1.000 EA
NP1256L	ALUM UL CSA CC INDUSTRIAL MOTOR A60	1.000 EA
34PA1002	PKG GRP, PRINT PK1001A01	1.000 EA

Accessories		
Part Number	Description	Multiplier
34-3900T	C-FACE KIT	A8

AC Induction Motor Performance Data

Record # 6611 - Typical performance - not guaranteed values

Winding: 34WG0895-R001	Type: 3410M	Enclosure: TEFC
-------------------------------	--------------------	------------------------

Nameplate Data				460 V, 60 Hz: High Voltage Connection	
Rated Output (HP)	.25			Full Load Torque	0.75 LB-FT
Volts	230/460			Start Configuration	direct on line
Full Load Amps	1.3/.65			Breakdown Torque	3.47 LB-FT
R.P.M.	1725			Pull-up Torque	2.27 LB-FT
Hz	60	Phase	3	Locked-rotor Torque	2.57 LB-FT
NEMA Design Code	B	KVA Code	L	Starting Current	3.45 A
Service Factor (S.F.)	1.35			No-load Current	0.6 A
NEMA Nom. Eff.	64	Power Factor	56	Line-line Res. @ 25°C	68.4 Ω
Rating - Duty	40C AMB-CONT			Temp. Rise @ Rated Load	42°C
S.F. Amps	1.6/.8			Temp. Rise @ S.F. Load	55°C

Load Characteristics 460 V, 60 Hz, 0.25 HP

% of Rated Load	25	50	75	100	125	150	S.F.
Power Factor	30	39	50	57	64	69	66
Efficiency	40	55.6	62.3	64	64.8	64.3	64.6
Speed	1785	1772	1758	1743	1729	1713	1722
Line amperes	0.64	0.65	0.66	0.67	0.74	0.79	0.76

Performance Graph at 460V, 60Hz, 0.25HP Typical performance - Not guaranteed values

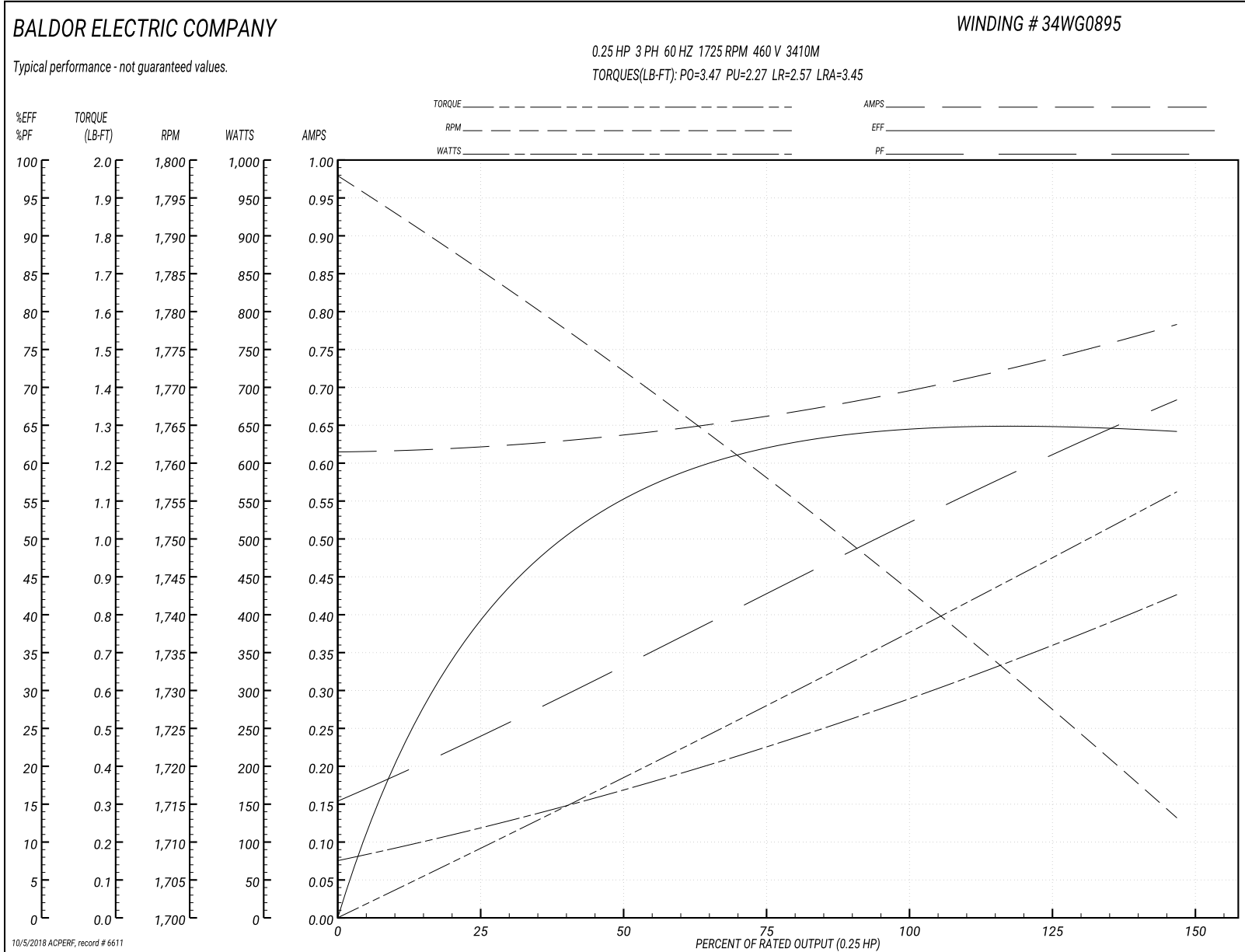

34LYA051

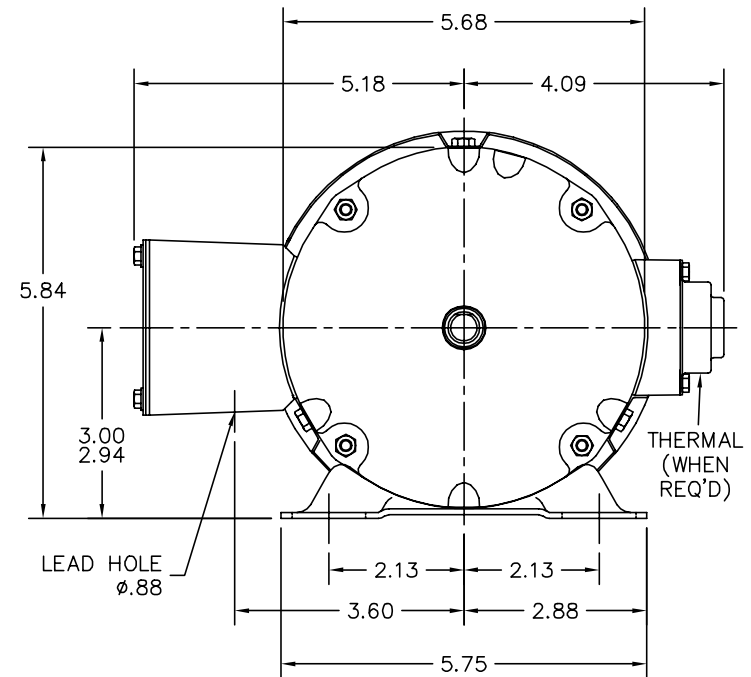
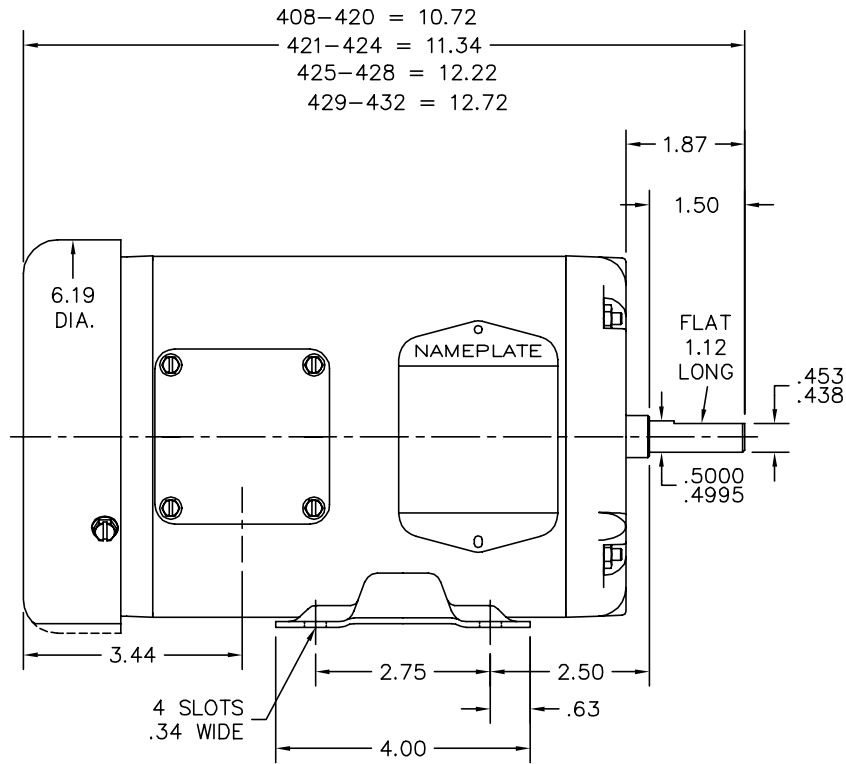

CUSTOMER IS RESPONSIBLE FOR DETERMINING THAT BALDOR'S PRODUCT WILL PERFORM SUITABLY IN THE INTENDED APPLICATION.

REV. DESC: CHG 34SH1174- TO 34SH1174		
REV. LTR: L	VERSION: 04	TDR: 000001004283
FILE: \AAA\00006\622	REVISED: 02: 45:12 11/09/2016	BY: ENBENBO
MTL: -	© □	

BALDOR

STD HORZ 34M NEMA 48 TEFC
 SH 1 of 1

34LYA051

CD0005



LOW VOLTAGE
(2Y)

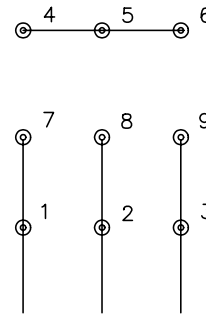

LINE

HIGH VOLTAGE
(1Y)

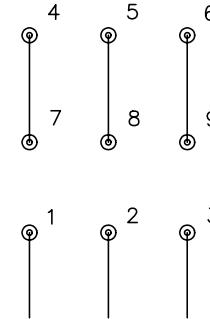

LINE

NOTES:

1. INTERCHANGE ANY TWO LINE LEADS TO REVERSE ROTATION.
2. OPTIONAL THERMOSTATS ARE PROVIDED WHEN SPECIFIED.
3. ACTUAL NUMBER OF INTERNAL PARALLEL CIRCUITS MAY BE A MULTIPLE OF THOSE SHOWN ABOVE.
4. LEAD COLORS ARE OPTIONAL. LEADS MUST ALWAYS BE NUMBERED AS SHOWN.

REV. DESC: REVISE TO SHOW OPTIONAL COLORS

REV. LTR: E BY: JLP

REVISED: 01/19/99 10:15

TDR: 0171435

90000

FILE: AAA00005140

MDL: -

MTL: -

BALDOR ELECTRIC Co.

3PH, DV, 9 LEADS

CD0005