

QUICK RELEASE LATCHES
SPOT WELDED TO TUB
(3 PL.)

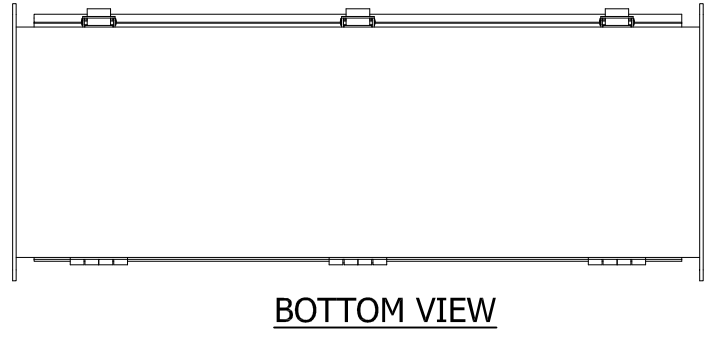
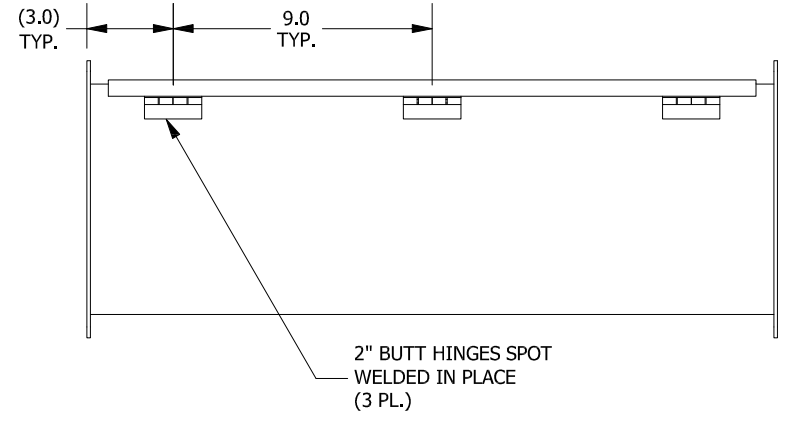
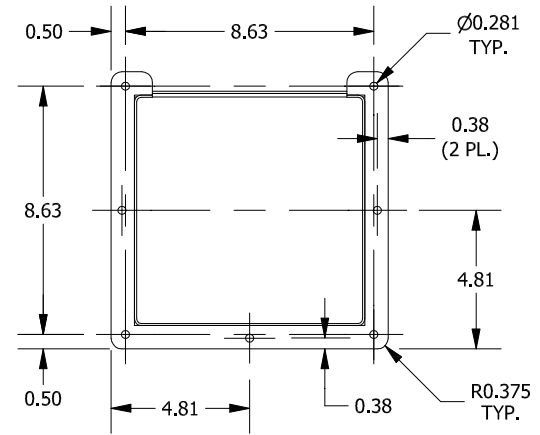

PART#: LJW82
(DATA SUBJECT TO CHANGE WITHOUT NOTICE)

THIS DRAWING IS PROPERTY OF HUBBELL INC. WIEGMANN
ALL INFORMATION IS PROPRIETARY AND NOT TO BE DUPLICATED