

MRC double-row ball bearings are manufactured in two main types: C-type (conrad construction) and M-type (maximum capacity with filling notches). Each row has a 30° contact angle.

C-type

Conrad construction, or C-type, double-row ball bearings have contact angles that converge outside the bearing, thereby increasing resistance to misalignment. This type does not have filling notches. These bearings are recommended for applications where single-row bearings are inadequate, but radial loads are not so great as to suggest a filling-notch bearing. They will take heavy radial loads, and axial loads equally in either direction. The C-type design fully meets the requirements of American Petroleum Institute Specification 610.

Both the inner and the outer rings have closure grooves. These bearings are available with seals, shields, and snap-rings.

M-type

This type has filling notches on one side to permit assembling the maximum number of balls into the bearing. Contact angles converge outside the bearing. All inner and outer rings have closure grooves. These bearings may be equipped with seals, shields, or snap-rings; or a combination of these. The M-type bearing has very heavy radial capacity. It also has thrust capacity in one direction, with the ability to accommodate light thrust load in the reversing direction.

Part numbers on M-type double-row bearings are normally located on either the side face or the O.D. The side face marking is always on the side opposite the filling notch and the O.D. marking is offset from the center away from the filling notch. Therefore, double sealed or shielded bearings with the filling notch covered from view can be oriented correctly.

Ball Cages and Types

The cage supplied with C-type and M-type bearings is one-piece, heat-treated steel for maximum retention. It is snapped into place after the full quota of balls has been introduced between the inner and outer ring.

Size	Series	Page
5200C	Light, Non-Filling Notch	149
5200C1	Light, Extra Width, Non-Filling Notch	149
5300C	Medium, Non-Filling Notch	150
5300C1	Medium, Extra Width, Non-Filling Notch	150
5400C	Heavy, Non-Filling Notch	153
5200M	Light, Filling Notch	151
5200M1	Light, Extra Width, Filling Notch	151
5300M	Medium, Filling Notch	152
5300M1	Medium, Extra Width, Filling Notch	152
Equivalent Load and Life		154
Life Calculation Examples		155
Width Summary and Interchange to New C & M from Old Series		141
Filling Notch Location on Closed Bearings		144
Internal Clearance		145
Thrust Rating		146
Extra Wide Retrofit Kit and Mounting Instructions		147

MRC 5000 type double-row bearings are made in three series — 5200 Light, 5300 Medium, and 5400 Heavy — each with progressively larger sections. The old-style 5000 type double-rows are available in the SB Conrad and maximum capacity configurations. The SB Conrad version has contact angles which diverge inwardly, thereby increasing resistance to misalignment. The maximum capacity version has contact angles which converge inwardly, giving it the capability of handling moderate misalignment. It also has filling notches on both sides, for the introduction of a maximum complement of balls.

Our new-style double-row bearings are available in the C-type (Conrad construction) and M type (with filling notches on one side only). Both types feature inwardly diverging contact angles, which provide greater rigidity than found in previous double-row filling-notch type bearings.

A unique manufacturing system utilizing “common parts” is employed in the manufacture of the new-style bearings. Using a minimum number of components, the system provides greater flexibility for producing either conrad or maximum-capacity types as open bearings or with a variety of closures. Twenty-two variations of a single bearing size can be made, for a total of 1185 double-row bearing variations to solve your application problems.

This chart outlines the suffixes and widths of MRC 5000 type bearings. The data on this chart do not represent actual availability of double-row products. These data are intended to be used as references for interchanging. New style double-rows appear next to their old-style counterparts that are the same width.

MRC Double-Row Suffix Identification Summary

Suffix	Description
B	Rigid construction, maximum capacity
BK	Rigid construction, maximum capacity, standard width
C	Conrad, rigid construction, standard width
C1	1/8" additional width from standard; 5205C1 & 5212C1 are 1/16" wider than standard
F	One shield
FF	Two shields
G	One snap-ring
K	Standard width
M	Maximum capacity, rigid construction, standard width

Suffix	Description
M1	1/8" additional width from standard; 5205M1 & 5212M1 are 1/16" wider than standard
Plain	Maximum capacity, nonrigid construction, narrow width in 5200 series, extra width is required with closures
S	Conrad construction (note: always combined with additional suffix letters)
SB	Conrad, rigid construction, narrow width, extra width is required with closures
SBK	Conrad, rigid construction, standard width
Z	One seal
ZZ	Two seals

Basic Bearing Number	Old— Style Suffix	New— Style Suffix	Width (inches)	Basic Bearing Number	Old— Style Suffix	New— Style Suffix	Width (inches)	Basic Bearing Number	Old— Style Suffix	New— Style Suffix	Width (inches)
5200 Series				5206	F	MF1	11/16	5211	BK	M	15/16
5106	SBZZ		29/32		K	M	15/16		BKG	MG	15/16
5200	SB		9/16		KF	MF	15/16		K	M	15/16
	SBKF		9/16		KFF	MFF	15/16		KF	MF	15/16
	SBKFF		9/16		KG	MG	15/16		KFG	MFG	15/16
	SBKZ		9/16		Plain		3/4		KG	MG	15/16
	SBKZZ		9/16		SBF	CF1	11/16		Plain		13/16
5201	SB		5/8		SBK	C	15/16			C	15/16
	SBFG		5/8		SBKF	CF	15/16	5212	F	MF1	11/2
	SBKF		5/8		SBKFF	CFF	15/16		FG	MFG1	11/2
	SBKFF		5/8		SBKFFG	CFFG	15/16		K	M	17/16
	SBKFFG		5/8		SBKFG	CFG	15/16		KF	MF	17/16
	SBKFG		5/8		SBKG	CG	15/16		KFG	MFG	17/16
	SBKZ		5/8		SBZZ	CZZ1	11/16		KG	MG	17/16
	SBKZZ		5/8		SBKZZG	CZZG1	11/16		Plain		13/8
5202	Plain		5/8		—	C1, M1	11/16		—	C1, M1	11/2
	SB		5/8	5207	F	MF1	13/16		—	C	17/16
	SBFG		11/16		K	M	11/16	5213	K	M	11/2
	SBKF		5/8		KF	MF	11/16		KF	MF	11/2
	SBKFF		5/8		KFF	MFF	11/16		KFG	MFG	11/2
	SBKFG		5/8		KFG	MFG	11/16		KG	MG	11/2
	SBKZZ		5/8		KG	MG	11/16		Plain		13/8
5203	SB		11/16		Plain		7/8		—	C	11/2
	SBKF		11/16		SBK	C	11/16	5214	K	M	19/16
	SBKFF		11/16		SBKF	CF	11/16		KF	MF	19/16
	SBKFFG		11/16		SBKFF	CFF	11/16		KFG	MFG	19/16
	SBKFG		11/16		SBKFG	CFG	11/16		KG	MG	19/16
	SBKZ		11/16		SBKFFG	CFFG	11/16		Plain		17/16
	SBKZZ		11/16		SBKFG	CFG	11/16		—	C	19/16
5204	Plain		3/4		SBKFFG	CFFG	11/16	5215	K	M	15/8
	K	M	13/16		SBKG	CG	11/16		KF	MF	15/8
	KF	MF	13/16		—	C1, M1	13/16		KFF	MFF	15/8
	SB		3/4	5208	BKF	MF	13/16		KFG	MFG	15/8
	SBK	C	13/16		BKFF	MFF	13/16		KG	MG	15/8
	SBKF	CF	13/16		K	M	13/16		Plain		17/16
	SBKFF	CFF	13/16		KF	MF	13/16		—	C	15/8
	SBKFFG	CFFG	13/16		KFF	MFF	13/16	5216	BFF		17/8
	SBKFG	CFG	13/16		KFG	MFG	13/16		K	M	13/4
	SBKG	CG	13/16		KG	MG	13/16		KF	MF	13/4
	SBKZ	CZ	13/16		Plain		1		KFG	MFG	13/4
5205	F	MF1	7/8		SBK	C	13/16		KG	MG	13/4
	K	M	13/16		SBKF	CF	13/16		Plain		15/8
	KG	MG	13/16		SBKFF	CFF	13/16		—	C	13/4
	Plain		3/4		SBKFG	CFG	13/16	5217	K	M	115/16
	SB		3/4		SBKFG	CFG	13/16		KF	MF	115/16
	SBF	CF1	7/8	5209	SBKG	CG	13/16		KG	MG	115/16
	SBK	C	13/16		K	M	13/16		Plain		13/4
	SBKF	CF	13/16		KF	MF	13/16		—	C	115/16
	SBKFF	CFF	13/16		KG	MG	13/16	5218	K	M	21/16
	SBKFFG	CFFG	13/16		Plain		1		KF	MF	21/16
	SBKFG	CFG	13/16		SBK	C	13/16		KG	MG	21/16
	SBKG	CG	13/16		SBKF	CF	13/16		Plain		2
	—	C1, M1	7/8		SBKFF	CFF	13/16		—	C	21/16
				5210	K	M	13/16				
					KF	MF	13/16				
					KFF	MFF	13/16				
					KG	MG	13/16				
					Plain		1				
					—	C	13/16				

5000 Series Bearings Suffix, Width Summary

MRC Bearing Services

Basic Bearing Number	Old— Style Suffix	New— Style Suffix	Width (inches)	Basic Bearing Number	Old— Style Suffix	New— Style Suffix	Width (inches)	Basic Bearing Number	Old— Style Suffix	New— Style Suffix	Width (inches)
5219	G		2 ³ / ₁₆		FG	MFG1	1 ¹ / ₂		Plain	M	2 ¹ / ₁₆
	Plain		2 ³ / ₁₆		G	MG	1 ³ / ₈		—	C	2 ¹ / ₁₆
5220	G		2 ³ / ₈		KF	MF	1 ³ / ₈		—	C1, M1	2 ¹³ / ₁₆
	Plain		2 ³ / ₈		KFG	MFG	1 ³ / ₈	5316	G	MG	2 ¹ / ₁₆
5221	Plain		2 ⁹ / ₁₆		Plain	M	1 ³ / ₈		Plain	M	2 ¹ / ₁₆
5222	KF		2 ³ / ₄		—	C1, M1	1 ¹ / ₂		—	C	2 ¹ / ₁₆
	Plain		2 ³ / ₄	5308	—	C	1 ³ / ₈	5317	Plain	—	2 ⁷ / ₈
5300 Series					BG	MG	1 ⁷ / ₁₆		—	C	2 ⁷ / ₈
5300	SB		3/4		F	MF1	1 ⁹ / ₁₆	5318	Plain	—	2 ⁷ / ₈
5301	SB		3/4		FG	MFG1	1 ⁹ / ₁₆		—	C	2 ⁷ / ₈
5302	Plain		3/4		G	MG	1 ⁷ / ₁₆	5319	Plain	—	3 ¹ / ₁₆
	SB		3/4		Plain	M	1 ⁷ / ₁₆		—	C	3 ¹ / ₁₆
5303	G		7/8		—	C	1 ⁷ / ₁₆	5320	Plain	—	3 ¹ / ₄
	KF		7/8	5309	—	C1, M1	1 ⁹ / ₁₆		Plain	—	3 ¹ / ₁₆
	KFG		7/8		B	M	1 ⁹ / ₁₆	5321	Plain	—	3 ⁷ / ₁₆
	SB		7/8		F	MF1	1 ¹¹ / ₁₆	5322	Plain	—	3 ⁵ / ₈
	SBG		7/8		FG	MFG1	1 ¹¹ / ₁₆	5400 Series			
	SBKF		7/8		G	MG	1 ⁹ / ₁₆	5403	Plain	—	1 ³ / ₁₆
	SBKFF		7/8		Plain	M	1 ⁹ / ₁₆	5404	Plain	—	1 ³ / ₈
	SBKFG		7/8		—	C	1 ⁹ / ₁₆	5405	Plain	—	1 ³ / ₈
					—	C1, M1	1 ¹¹ / ₁₆	5406	Plain	—	1 ⁹ / ₁₆
5304	F	MF1	1	5310	F	MF1	1 ⁷ / ₈		—	C	1 ⁹ / ₁₆
	Plain	M	7/8		FG	MFG1	1 ⁷ / ₈	5407	G	—	1 ³ / ₄
	SB	C	7/8		G	MG	1 ³ / ₄		Plain	—	1 ³ / ₄
	SBF	CF1	1		KF	MF	1 ³ / ₄		—	C	1 ³ / ₄
	SBG	CG	7/8		KFG	MFG	1 ³ / ₄	5408	Plain	—	1 ¹⁵ / ₁₆
	SBKF	CF	7/8		Plain	M	1 ³ / ₄		—	C	1 ¹⁵ / ₁₆
	SBKFF	CFF	7/8		—	C	1 ³ / ₄	5409	G	—	2 ¹ / ₈
	SBKFFG	CFFG	7/8		—	C1, M1	1 ⁷ / ₈		Plain	—	2 ¹ / ₈
	SBKFG	CFG	7/8	5311	F	MF1	2 ¹ / ₁₆		—	C	2 ¹ / ₈
	—	C1, M1	1		FG	MFG1	2 ¹ / ₁₆	5410	F	—	2 ⁷ / ₁₆
5305	F		1 ¹ / ₈		G	MG	1 ¹⁵ / ₁₆		Plain	—	2 ⁵ / ₁₆
	FG		1 ¹ / ₈		Plain	M	1 ¹⁵ / ₁₆	5411	F	—	2 ⁵ / ₈
	G	MG	1		—	C	1 ¹⁵ / ₁₆		G	—	2 ¹ / ₂
	KFF	MFF	1		—	C1, M1	2 ¹ / ₁₆		Plain	—	2 ¹ / ₂
	Plain	M	1	5312	F	MF1	2 ¹ / ₄	5412	Plain	—	2 ⁵ / ₈
	SB	C	1		FG	MFG1	2 ¹ / ₄		—	C	2 ⁵ / ₈
	SBF		1 ¹ / ₈		G	MG	2 ¹ / ₈	5413	Plain	—	2 ¹³ / ₁₆
	SBFG		1 ¹ / ₈		Plain	M	2 ¹ / ₈		—	C	2 ¹³ / ₁₆
	SBG	CG	1		—	C	2 ¹ / ₈	5414	Plain	—	3 ¹ / ₈
	SBKF	CF	1		—	C1, M1	2 ¹ / ₄		—	C	3 ¹ / ₈
	SBKFF	CFF	1	5313	F	MF1	2 ⁷ / ₁₆	5415	Plain	—	3 ¹ / ₄
	SBKFG	CFG	1		FG	MFG1	2 ⁷ / ₁₆		—	C	3 ¹ / ₄
5306	B	M	1 ³ / ₁₆		G	MG	2 ⁵ / ₁₆	5416	Plain	—	3 ⁷ / ₁₆
	BKFF	MFF	1 ³ / ₁₆		Plain	M	2 ⁵ / ₁₆		—	C	3 ⁷ / ₁₆
	F	MF1	1 ⁵ / ₁₆		—	C	2 ⁵ / ₁₆	5417	Plain	—	3 ⁵ / ₈
	FG	MFG1	1 ⁵ / ₁₆		—	C1, M1	2 ⁷ / ₁₆		—	C	3 ⁵ / ₈
	G	MG	1 ³ / ₁₆	5314	F	MF1	2 ⁵ / ₈	5418	Plain	—	3 ⁷ / ₈
	KF	MF	1 ³ / ₁₆		G	MG	2 ¹ / ₂		—	C	3 ⁷ / ₈
	KFF	MFF	1 ³ / ₁₆		KF	MF	2 ¹ / ₂	5419	Plain	—	4 ³ / ₁₆
	KFG	MFG	1 ³ / ₁₆		KFG	MFG	2 ¹ / ₂				
	Plain	M	1 ³ / ₁₆		Plain	M	2 ¹ / ₂				
	—	C1, M1	1 ⁵ / ₁₆		—	C	2 ¹ / ₂				
	—	C	1 ³ / ₁₆		—	C1, M1	2 ⁵ / ₈				
5307	BKFF	MFF	1 ³ / ₈	5315	F	MF1	2 ¹³ / ₁₆				
	F	MF1	1 ¹ / ₂		G	MG	2 ¹ / ₁₆				

Bearing numbers of MRC double-row ball bearings produced before 1983 differ from the new C- and M-types listed in this catalog. Shown below is the interchange of pre-1983 bearing numbers with the new C- and M-types.

5000 Series double-row bearings not listed here maintain the original bearing number and must be specified by that number when ordering.

MRC Bearing Numbers		MRC Bearing Numbers		MRC Bearing Numbers	
Prior to 1983	Superseded by	Prior to 1983	Superseded by	Prior to 1983	Superseded by
5200SB	5200C*	5211K	5211M	5306	5306M
5200SBKF	5200CF*	5211KF	5211MF	5306F	5306MF-1
5200SBKFF	5200CFF*	5211KFG	5211MFG	5306FG	5306MFG-1
5200SBKZ	5200CZ*	5211KG	5211MG	5306G	5306MG
5200SBKZZ	5200CZZ*	5212F	5212MF-1	5306KF	5306MF
5201SB	5201C*	5212FG	5212MFG-1	5306KFF	5306MFF
5201SBKF	5201CF*	5212K	5212M	5306KFG	5306MFG
5201SBKFF	5201CFF*	5212KF	5212MF	5307	5307M
5201SBKZ	5201CZ*	5212KFG	5212MFG	5307F	5307MF-1
5201SBKZZ	5201CZZ*	5212KG	5212MG	5307FG	5307MFG-1
5202SB	5202C*	5213K	5213M	5307G	5307MG
5202SBKFF	5202CF*	5213KF	5213MF	5307KF	5307MF
5202SBFG	5202CFG-1*	5213KFG	5213MFG	5307KFG	5307MFG
5202SBKFG	5202CFG*	5213KG	5213MG	5308	5308M
5202SBKZ	5202CZ*	5214K	5214M	5308F	5308MF-1
5202SBKZZ	5202CZZ*	5214KF	5214MF	5308FG	5308MFG-1
5203SB	5203C*	5214KG	5214MG	5308G	5308MG
5203SBKF	5203CF*	5215K	5215M	5309	5309M
5203SBKFF	5203CFF*	5215KF	5215MF	5309B	5309M
5203SBKFG	5203CFG*	5215KFF	5215MFF	5309F	5309MF-1
5203SBKZ	5203CZ*	5215KFG	5215MFG	5309FG	5309MFG-1
5203SBKZZ	5203CZZ*	5215KG	5215MG	5309G	5309MG
5204SBK	5204C	5216K	5216M	5310	5310M
5204SBKF	5204CF	5216KF	5216MF	5310F	5310MF-1
5204SBKFF	5204CFF	5216KFG	5216MFG	5310FG	5310MFG-1
5204SBKFG	5204CFG	5216KG	5216MG	5310G	5310MG
5204SBKFFG	5204CFFG	5217K	5217M	5310KF	5310MF
5204SBKG	5204CG	5217KF	5217MF	5310KFG	5310MFG
5204SBKZ	5204CZ	5217KG	5217MG	5311	5311M
5205SBK	5205C	5218K	5218M	5311F	5311MF-1
5205SBF	5205CF-1	5218KF	5218MF	5311FG	5311MFG-1
5205SBKF	5205CF	5218KFG	5218MG	5311G	5311MG
5205SBKFF	5205CFF	5219	5219G	5312	5312M
5205SBKG	5205CG	5219G	5219G	5312F	5312MF-1
5206SBK	5206C	5220	5220G	5312FG	5312MFG-1
5206SBF	5206CF-1	5220G	5220G	5312G	5312MG
5206SBKF	5206CF	5221	5221G	5313	5313M
5206SBKFF	5206CFF	5221	5221G	5313F	5313MF-1
5206SBKFG	5206CFG	5222	5222G	5313FG	5313MFG-1
5206SBKG	5206CG	5222KF	5222KF	5313G	5313MG
5206SBZZ	5206CZZ-1	5300SB	5300C*	5314	5314M
5207F	5207MF-1	5301SB	5301C*	5314F	5314MF-1
5207SBK	5207C	5302SB	5302C*	5314G	5314MG
5207SBKF	5207CF	5303SB	5303C*	5314KF	5314MF
5207SBKFF	5207CFF	5303SBG	5303CG*	5315	5315M
5207SBKFG	5207CFG	5303SBKF	5303CF*	5315F	5315MF1
5207SBKG	5207CG	5303SBKFF	5303CFF*	5315G	5315MG
5208SBK	5208C	5303SBKFG	5303CFG*	5316	5316M
5208SBKF	5208CF	5304SB	5304C	5316G	5316MG
5208SBKFF	5208CFF	5304SBF	5304CF-1	5317	5317
5208SBKFG	5208CFG	5304SBKF	5304CF	5318	5318
5208SBKG	5208CG	5304SBKFF	5304CFF	5319	5319
5209K	5209M	5305SB	5305C	5320	5320
5209KF	5209MF	5305SBG	5305CG	5321	5321
5209SBFF	5209CFF	5305SBKF	5305CF	5322	5322
5209KG	5209MG	5305SBKFF	5305CFF		
5210K	5210M	5305SBKFG	5305CFG		
5210KF	5210MF				
5210KFF	5210MFF				
5210KG	5210MG				

*Listed for information only. Not currently in production. Use SB types.

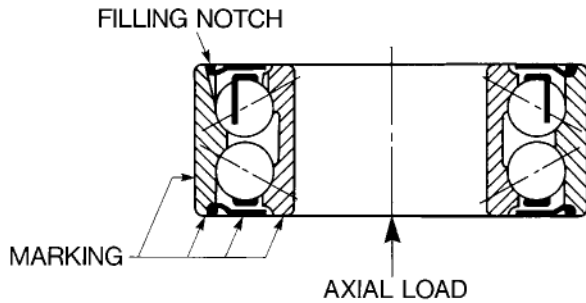
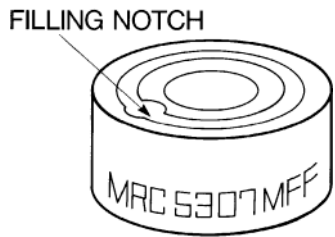

Since the filling notch row is not visible on 5000MFF and 5000MZZ bearings, it is necessary to identify which row has the notch in those cases where the bearing is subject to axial load. Axial load should be carried on the non-filling notch row. A moderate reversing axial load is permissible on the filling notch row.

A typical application of a 5000MFF or 5000MZZ bearing is shown above in which it is subjected to an axial load in an upward direction. The bearing should be mounted with the filling notch up so that the axial load is taken by the bottom, non-filling notch row.

The filling notch is oriented in relation to the bearing identification marking on the bearing which will be found in one of the following locations:

- Face of the outer ring
- Face of the inner ring
- OD surface of the outer ring
- Face of the closure

In each case the marking will occur on the side of the bearing opposite the filling notch as illustrated above. When the O.D. surface marking is "right side up" the filling notch is in the uppermost row and it is located closest to the non-filling notch row.



5000 Series Axial and Radial Internal Clearance

5200 and 5300 Series

Bore Diameter d				Axial Internal Clearance															
Over		Including		C2				Normal C0				C3				C4			
mm	in	mm	in	.001 mm		.0001 in		.001 mm		.0001 in		.001 mm		.0001 in		.001 mm		.0001 in	
				Min	Max	Min	Max	Min	Max	Min	Max	Min	Max	Min	Max	Min	Max	Min	Max
10	.3937	10	.3937	1	11	0	4	5	21	2	8	12	28	5	11	25	45	10	18
18	.7087	18	.7087	1	12	0	5	6	23	2	9	13	31	5	12	27	47	11	19
		24	.9449	2	14	1	6	7	25	3	10	16	34	6	13	28	48	11	19
24	.9449	30	1.1811	2	15	1	6	8	27	3	11	18	37	7	15	30	50	12	20
30	1.1811	40	1.5748	2	16	1	6	9	29	4	11	21	40	8	16	33	54	13	21
40	1.5748	50	1.9685	2	18	1	7	11	33	4	13	23	44	9	17	36	58	14	23
50	1.9685	65	2.5591	3	22	1	9	13	36	5	14	26	48	10	19	40	63	16	25
65	2.5591	80	3.1496	3	24	1	9	15	40	6	16	30	54	12	21	46	71	18	28
80	3.1496	100	3.9370	3	26	1	10	18	46	7	18	35	63	14	25	55	83	22	33
100	3.9370	110	4.3307	4	30	2	12	22	53	9	21	42	73	17	29	65	96	26	38

Bore Diameter d				Radial Internal Clearance															
Over		Including		C2				Normal C0				C3				C4			
mm	in	mm	in	.001 mm		.0001 in		.001 mm		.0001 in		.001 mm		.0001 in		.001 mm		.0001 in	
				Min	Max	Min	Max	Min	Max	Min	Max	Min	Max	Min	Max	Min	Max	Min	Max
10	.3937	10	.3937	0.6	7	0	2.4	3	13	1.2	5	8	18	3	7	15	27	6	11
18	.7087	18	.7087	0.6	7	0	3	3.6	14	1.2	5	8	18	3	7	18	27	7	11
		24	.9449	1.2	8	0.6	3.6	4	15	1.8	6	11	21	4	8	18	27	7	11
24	.9449	30	1.1811	1.2	9	0.6	3.6	5	16	1.8	7	11	23	4	9	18	31	7	12
30	1.1811	40	1.5748	1.2	10	0.6	3.6	5	17	2.4	7	12	25	5	10	21	33	8	13
40	1.5748	50	1.9685	1.2	11	0.6	4	7	20	2.4	8	12	25	5	10	21	36	8	14
50	1.9685	65	2.5591	1.8	13	0.6	5	8	22	3	8	15	27	6	11	25	38	10	15
65	2.5591	80	3.1496	1.8	14	0.6	5	9	24	3.6	10	18	33	7	13	27	44	11	17
80	3.1496	100	3.9370	1.8	16	0.6	6	11	28	4	11	21	38	8	15	33	50	13	20
100	3.9370	110	4.3307	2.4	18	1.2	7	13	32	5	13	25	44	10	17	40	58	16	23

5400 Series

Bore Diameter d				Axial Internal Clearance															
Over		Including		C2				Normal C0				C3				C4			
mm	in	mm	in	.001 mm		.0001 in		.001 mm		.0001 in		.001 mm		.0001 in		.001 mm		.0001 in	
				Min	Max	Min	Max	Min	Max	Min	Max	Min	Max	Min	Max	Min	Max	Min	Max
30	1.1811	30	1.1811	2	15	1	6	8	27	3	11	28	47	11	19	45	75	18	30
40	1.5748	40	1.5748	2	16	1	6	9	29	4	11	31	50	12	20	48	84	19	33
		50	1.9685	2	18	1	7	11	33	4	13	33	54	13	21	51	90	20	35
50	1.9685	65	2.5591	3	22	1	9	13	36	5	14	36	58	14	23	55	96	22	38
65	2.5591	70	2.7559	3	24	1	9	15	40	6	16	40	64	16	25	61	106	24	42
70	2.7559	80	3.1496	0	165	0	65	165	305	65	120	305	430	120	170	430	510	170	200
80	3.1496	90	3.5433	0	200	0	80	200	360	80	140	360	480	140	190	480	610	190	240

Bore Diameter d				Radial Internal Clearance															
Over		Including		C2				Normal C0				C3				C4			
mm	in	mm	in	.001 mm		.0001 in		.001 mm		.0001 in		.001 mm		.0001 in		.001 mm		.0001 in	
				Min	Max	Min	Max	Min	Max	Min	Max	Min	Max	Min	Max	Min	Max	Min	Max
30	1.1811	30	1.1811	1	8	0.4	3	2	13	1	5	13	23	5	9	20	38	8	15
40	1.5748	40	1.5748	1	8	0.5	3	6	13	2	5	15	23	6	9	23	41	9	16
		50	1.9685	1	8	0.5	3	6	15	2	6	15	25	6	10	23	44	9	17
50	1.9685	65	2.5591	1	11	0.5	4	6	15	2	6	15	28	6	11	25	45	10	18
65	2.5591	70	2.7559	1	11	0.5	4	6	18	2	7	18	31	7	12	28	48	11	19
70	2.7559	80	3.1496	0	6	0	2	6	18	2	7	18	33	7	13	33	48	13	19
80	3.1496	90	3.5433	0	7	0	3	7	23	3	9	23	44	9	17	44	65	17	26

Thrust Rating Of Double-Row Ball Bearings-5000 Series

MRC Bearing Services

Dynamic Rating

To obtain dynamic thrust rating multiply dynamic radial rating C by the factor shown below.

Size	Factor
5200SB-5203SB	
5300SB-5303SB	0.71
5403C-5414C	
5204C&M-5218C&M	
5304C&M-5319C&M	0.81

Example:

Bearing size: 5307C

Basic dynamic radial load rating (C) = 11100 lbf

Thrust rating factor = 0.81

Thrust rating = $0.81 \times 11100 = 8991$

Static Rating

To obtain static thrust rating multiply static radial rating C_0 by the factor shown below.

Size	Factor
5200SB-5203SB	
5300SB-5303SB	
5204C&M-5206C&M	0.57
5403C-5414C	
5207C&M-5218C&M	
5304C&M-5319C&M	0.66

Sizes 5415C-5419C have 0° contact angles and are not included in the above tables. When thrust load is present, the equivalent radial load should be used to determine life.

Example:

Bearing size: 5214M

Basic static radial load rating (C_0) = 28100 lbf

Thrust rating factor = 0.66

Thrust rating = $0.66 \times 28100 = 18550$

Double-row ball bearings with non-standard extra wide width are currently available as a retrofit kit. These replacement units consist of a standard width double-row ball bearing and two specially designed spacers packaged together in a single carton.

Spacers

The Extra-Width Double-Row Ball Bearing Retrofit Kit is simple to use. When used with bearings without snap rings, place both spacers on the same side, as shown in Figure 1.

With snap ring bearings, the inner ring spacer must be installed on the side opposite the snap ring, as shown in Figure 2. The outer spacer is not needed in applications where the bearing's snap ring controls the axial location of the outer ring in the housing.

The spacers accommodate slight variations in the shaft and housing seat width. The inner ring and spacer can be secured to the shaft with a retaining ring or threaded

locknut. If a locknut is used, the amount of clamping force can be regulated to make slight adjustments in the shaft's axial location. The spacer rings yield slightly when an axial clamping force is applied. The spacer rings also exert a reaction force, which helps maintain the initial clamping force and helps prevent the inner ring from becoming loose on the shaft. The same circumstances apply to the outer ring spacers when an end cap is used to clamp the bearing's outer ring against a housing shoulder.

Because the spacer rings are designed to yield slightly when axial clamping forces are applied, the spacer rings should always be replaced with new spacer rings anytime the bearing is removed, replaced or reinstalled.

Materials for Rings, Balls and Spacers

High-carbon chromium vacuum-processed steel (SAE 52100) is used for all balls and rings. Machined and roll formed spacer rings are fabricated from 1018 carbon steel and 304 stainless steel.

Mounting Instructions

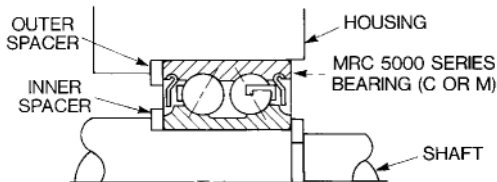

Figure 1

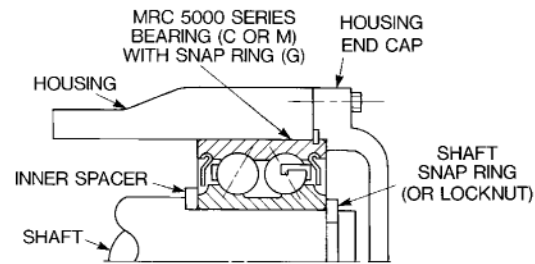

Figure 2

Without Snap Ring

1. Install inner and outer ring spacers onto the shaft and into the housing bore respectively.
2. Install bearing in accordance with normal mounting instructions.
3. If any locking devices such as snap rings or locknuts are normally used to secure the bearing on the shaft or in the housing be sure they are properly installed.
4. These inner and outer ring spacers are adjusted to proper width prior to installation. During bearing installation their width may be slightly altered to accommodate variations in shaft and housing shoulder distances. As a consequence, when a new extra width retrofit bearing kit is installed the new spacer rings supplied with the kit should always be used and the old spacers discarded.

With Snap Ring

1. Install the inner ring spacer onto the shaft. The outer ring spacer is not used with a snap ring bearing and may be discarded.
2. Install bearing in accordance with normal mounting instructions.
3. If any locking devices such as snap rings, locknuts or end caps are normally used to secure the bearing on the shaft or in the housing be sure they are properly installed.
4. These inner and outer ring spacers are adjusted to proper width prior to installation. During bearing installation their width may be slightly altered to accommodate variations in shaft and housing shoulder distances. As a consequence, when a new extra width retrofit bearing kit is installed the new spacer rings supplied with the kit should always be used and the old spacers discarded.

Part Numbers

MRC Bearing Services

A listing of available part numbers appears below. This listing may change with sizes being added or deleted based on demand.

MRC Part Number	Width including Spacers		
	Inches	mm	
5205CF1	$\frac{7}{8}$.8750	22.23
5205MF1*	$\frac{7}{8}$.8750	22.23
5206CF1	$1\frac{1}{16}$	1.0625	26.99
5206MF1	$1\frac{1}{16}$	1.0625	26.99
5206SBZZ	$1\frac{1}{16}$	1.0625	26.99
5212MF1	$1\frac{1}{2}$	1.5000	38.10
5304CF1	1	1.0000	25.40
5304MF1	1	1.0000	25.40
5305CF1	$1\frac{1}{8}$	1.1250	28.58
5305MFG1	$1\frac{1}{8}$	1.1250	28.58
5306MFG1	$1\frac{5}{16}$	1.3125	33.34
5306MF1	$1\frac{5}{16}$	1.3125	33.34
5307MF1	$1\frac{1}{2}$	1.5000	38.10
5307MFG1	$1\frac{1}{2}$	1.5000	38.10
5308MFG1	$1\frac{9}{16}$	1.5625	39.69
5308MF1	$1\frac{9}{16}$	1.5625	39.69
5309MFG1	$1\frac{11}{16}$	1.6875	42.86
5309MF1	$1\frac{11}{16}$	1.6875	42.86
5310MFG1	$1\frac{7}{8}$	1.8750	47.63
5310MF1	$1\frac{7}{8}$	1.8750	47.63
5311MFG1	$2\frac{1}{16}$	2.0625	52.39
5311MF1	$2\frac{1}{16}$	2.0625	52.39
5312MFG1	$2\frac{1}{4}$	2.2500	57.15
5312MF1	$2\frac{1}{4}$	2.2500	57.15
5313MFG1	$2\frac{7}{16}$	2.4375	61.91
5313MF1	$2\frac{7}{16}$	2.4375	61.91
5315MF1	$2\frac{13}{16}$	2.8125	71.44

*Currently stocked. No spacer needed.

Nomenclature

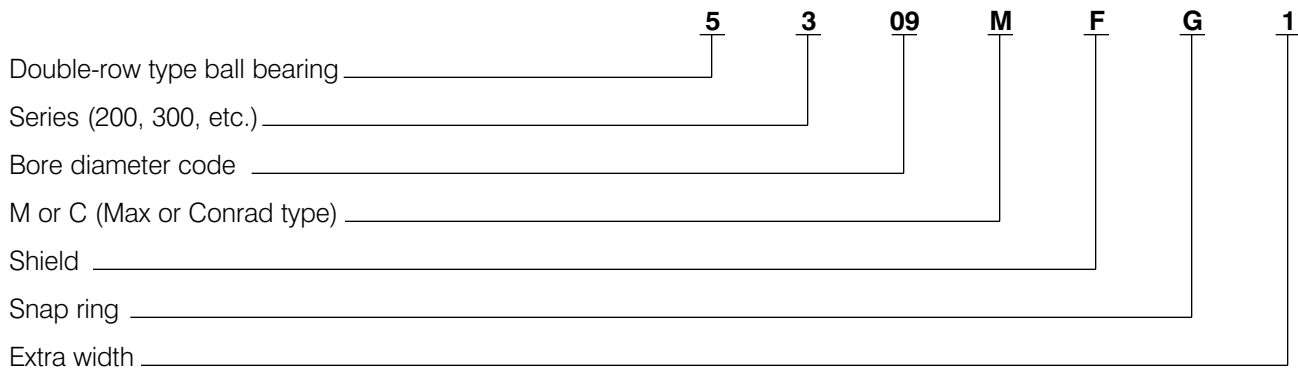

5200-C bearings are used with moderate to heavy radial loads, two-directional thrust loads, or a combination of both.

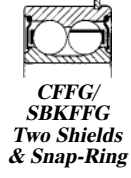
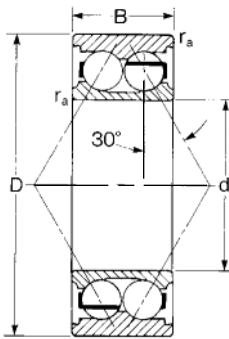

MRC Bearing Number	Bore		Outside Diameter D		Width B		Fillet Radius ¹⁾ r _a		Basic Radial Load Rating				Speed Rating ²⁾		
	d	in	mm	in	mm	in	mm	in	Dynamic C ³⁾		Static C ₀		Open and Shielded Oil Grease		Single and Double Sealed Grease
									N	lbf	N	lbf	RPM	RPM	RPM
5200-SB	10	.3937	30	1.1811	14.3	.5630	.64	.025	7 610	1 710	4 300	967	16 000	22 000	16 000
5201-SB	12	.4724	32	1.2598	15.9	.6260	.64	.025	10 400	2 340	5 600	1 260	15 000	20 000	15 000
5202-SB	15	.5906	35	1.3780	15.9	.6260	.64	.025	11 400	2 560	6 800	1 530	12 000	17 000	12 000
5203-SB	17	.6693	40	1.5748	17.5	.6890	.64	.025	14 300	3 210	8 800	1 980	10 000	15 000	10 000
5204-C	20	.7874	47	1.8504	20.6	.8110	1.0	.04	19 000	4 270	12 000	2 700	9 000	13 000	9 000
5205-C	25	.9843	52	2.0472	20.6	.8110	1.0	.04	20 800	4 680	14 000	3 150	8 000	11 000	8 000
5205-C1	25	.9843	52	2.0472	22.2	.8740	1.0	.04	20 800	4 680	14 000	3 150	8 000	11 000	8 000
5206-C	30	1.1811	62	2.4409	23.8	.9370	1.0	.04	28 600	6 430	20 400	4 590	7 000	9 500	7 000
5206-C1	30	1.1811	62	2.4409	27.0	1.0630	1.0	.04	28 600	6 430	20 400	4 590	7 000	9 500	7 000
5207-C	35	1.3780	72	2.8346	27.0	1.0630	1.0	.04	37 700	8 480	27 500	6 180	6 000	8 000	6 000
5207-C1	35	1.3780	72	2.8346	30.2	1.1890	1.0	.04	37 700	8 480	27 500	6 180	6 000	8 000	6 000
5208-C	40	1.5748	80	3.1496	30.2	1.1890	1.0	.04	44 900	10 100	34 000	7 640	5 600	7 500	5 600
5209-C	45	1.7717	85	3.3465	30.2	1.1890	1.0	.04	48 800	11 000	39 000	8 770	5 000	6 700	5 000
5210-C	50	1.9685	90	3.5433	30.2	1.1890	1.0	.04	48 800	11 000	39 000	8 770	4 800	6 300	4 800
5211-C	55	2.1654	100	3.9370	33.3	1.3110	1.5	.06	57 200	12 900	47 500	10 700	4 300	5 600	4 300
5212-C	60	2.3622	110	4.3307	36.5	1.4370	1.5	.06	70 200	15 800	58 500	13 200	3 800	5 000	3 800
5212-C1	60	2.3622	110	4.3307	38.1	1.5000	1.5	.06	70 200	15 800	58 500	13 200	3 800	5 000	3 800
5213-C	65	2.5591	120	4.7244	38.1	1.5000	1.5	.06	80 600	18 100	73 500	16 500	3 600	4 800	3 600
5214-C	70	2.7559	125	4.9213	39.7	1.5630	1.5	.06	88 400	19 900	80 000	18 000	3 200	4 300	3 200
5215-C	75	2.9528	130	5.1181	41.3	1.6260	1.5	.06	95 600	21 500	88 000	19 800	3 200	4 300	3 200
5216-C	80	3.1496	140	5.5118	44.4	1.7480	2.0	.08	106 000	23 900	95 000	21 400	2 800	3 800	2 800
5217-C	85	3.3465	150	5.9055	49.2	1.9370	2.0	.08	124 000	27 900	110 000	24 700	2 600	3 600	2 600
5218-C	90	3.5433	160	6.2992	52.4	2.0630	2.0	.08	130 000	29 300	120 000	27 000	2 400	3 400	2 400
5219-C	95	3.7402	170	6.6929	55.6	2.1890	2.0	.08	159 000	35 700	146 000	32 800	2 200	3 200	2 200
5220-C	100	3.9370	180	7.0866	60.3	2.3740	2.0	.08	178 000	40 000	166 000	37 300	2 000	3 000	2 000
5221-C	105	4.1339	190	7.4803	65.1	2.5630	2.0	.08	186 000	41 800	180 000	40 500	1 800	2 800	1 800
5222-C	110	4.3307	200	7.8740	69.8	2.7480	2.0	.08	203 000	45 600	200 000	45 000	1 600	2 600	1 600

¹⁾ Fillet radius indicates maximum fillet radius on shaft or in housing which bearing corner will clear.

²⁾ Listed values are for pressed steel cage, ABEC-1.

The values have been determined through historical application and practice. For a more complete explanation, see page 276.

³⁾ Rating for one million revolutions or 500 hours at 33 1/3 RPM.

Note: Extra width bearings identified by the suffix C1 are supplied with a retrofit kit described on pages 147, 148.

5300-C bearings are used with heavy radial loads, two-directional thrust loads, or a combination of both.

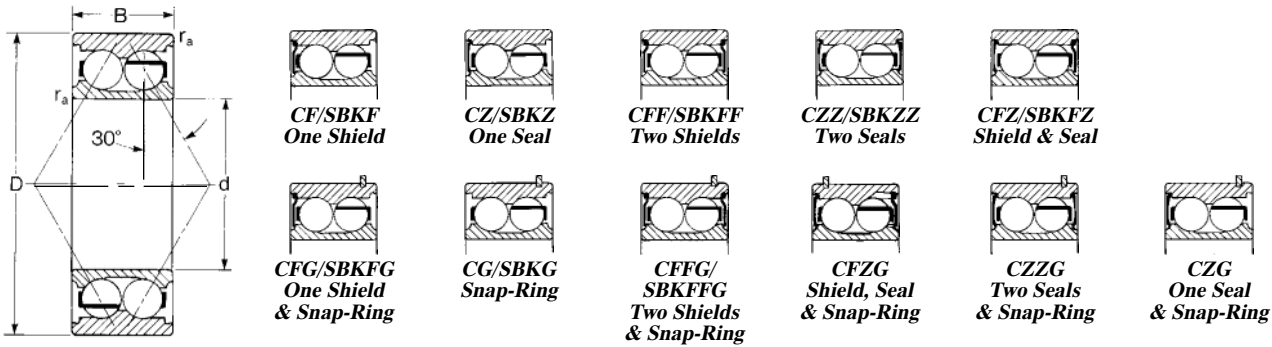

MRC Bearing Number	Bore		Outside Diameter D		Width B		Fillet Radius ¹⁾ r _a		Basic Radial Load Rating				Speed Rating ²⁾		
	d mm	in	mm	in	mm	in	mm	in	Dynamic C ³⁾		Static C ₀		Open and Shielded Grease Oil		Single and Double Sealed Grease
									N	lbf	N	lbf	RPM	RPM	RPM
5300-SB	10	.3937	35	1.3780	19.1	.7520	.64	.025	10 600	2 380	6 100	1 370	15 000	20 000	15 000
5301-SB	12	.4724	37	1.4567	19.1	.7520	1.0	.04	11 700	2 630	6 800	1 530	14 000	18 000	14 000
5302-SB	15	.5906	42	1.6535	19.1	.7520	1.0	.04	15 100	3 390	9 300	2 090	11 000	15 000	11 000
5303-SB	17	.6693	47	1.8504	22.2	.8740	1.0	.04	21 600	4 860	12 700	2 860	11 000	14 000	11 000
5304-C	20	.7874	52	2.0472	22.2	.8740	1.0	.04	22 500	5 060	14 600	3 280	8 500	12 000	8 500
5304-C1	20	.7874	52	2.0472	25.4	1.0000	1.0	.04	22 500	5 060	14 600	3 280	8 500	12 000	8 500
5305-C	25	.9843	62	2.4409	25.4	1.0000	1.0	.04	30 700	6 910	20 400	4 590	7 500	10 000	7 500
5306-C	30	1.1811	72	2.8346	30.2	1.1890	1.0	.04	41 600	9 360	29 000	6 520	6 300	8 500	6 300
5306-C1	30	1.1811	72	2.8346	33.3	1.3110	1.0	.04	41 600	9 360	29 000	6 520	6 300	8 500	6 300
5307-C	35	1.3780	80	3.1496	34.9	1.3740	1.5	.06	49 400	11 100	34 500	7 760	5 600	7 500	5 600
5307-C1	35	1.3780	80	3.1496	38.1	1.5000	1.5	.06	49 400	11 100	34 500	7 760	5 600	7 500	5 600
5308-C	40	1.5748	90	3.5433	36.5	1.4370	1.5	.06	60 500	13 600	43 000	9 760	5 000	6 700	5 000
5308-C1	40	1.5748	90	3.5433	39.7	1.5630	1.5	.06	60 500	13 600	43 000	9 760	5 000	6 700	5 000
5309-C	45	1.7717	100	3.9370	39.7	1.5630	1.5	.06	72 800	16 400	53 000	11 900	4 500	6 000	4 500
5309-C1	45	1.7717	100	3.9370	42.9	1.6890	1.5	.06	72 800	16 400	53 000	11 900	4 500	6 000	4 500
5310-C	50	1.9685	110	4.3307	44.4	1.7480	2.0	.08	85 200	19 200	64 000	14 400	4 000	5 300	4 000
5310-C1	50	1.9685	110	4.3307	47.6	1.8740	2.0	.08	85 200	19 200	64 000	14 400	4 000	5 300	4 000
5311-C	55	2.1654	120	4.7244	49.2	1.9370	2.0	.08	106 000	23 900	81 500	18 300	3 800	5 000	3 800
5311-C1	55	2.1654	120	4.7244	52.4	2.0630	2.0	.08	106 000	23 900	81 500	18 300	3 800	5 000	3 800
5312-C	60	2.3622	130	5.1181	54.0	2.1260	2.0	.08	121 000	27 200	95 000	21 400	3 400	4 500	3 400
5312-C1	60	2.3622	130	5.1181	57.2	2.2520	2.0	.08	121 000	27 200	95 000	21 400	3 400	4 500	3 400
5313-C	65	2.5591	140	5.5118	58.7	2.3110	2.0	.08	138 000	31 100	108 000	24 300	3 200	4 300	3 200
5313-C1	65	2.5591	140	5.5118	61.9	2.4370	2.0	.08	138 000	31 100	108 000	24 300	3 200	4 300	3 200
5314-C	70	2.7559	150	5.9055	63.5	2.6970	2.0	.08	153 000	34 400	125 000	28 100	2 800	3 800	2 800
5314-C1	70	2.7559	150	5.9055	66.7	2.6260	2.0	.08	153 000	34 400	125 000	28 100	2 800	3 800	2 800
5315-C	75	2.9528	160	6.2992	68.3	2.6890	2.0	.08	168 000	37 800	140 000	31 500	2 600	3 600	2 600
5315-C1	75	2.9528	160	6.2992	71.4	2.8110	2.0	.08	168 000	37 800	140 000	31 500	2 600	3 600	2 600
5316-C	80	3.1496	170	6.6929	68.3	2.6890	2.0	.08	182 000	41 000	156 000	35 100	2 400	3 400	2 400
5317-C	85	3.3465	180	7.0866	73.0	2.8740	2.5	.10	195 000	43 900	176 000	39 600	2 200	3 200	2 200
5318-C	90	3.5433	190	7.4803	73.0	2.8740	2.5	.10	212 000	47 700	196 000	44 100	2 000	3 000	2 000
5319-C	95	3.7402	200	7.8740	77.8	3.0430	2.5	.10	234 000	52 700	224 000	50 400	1 900	2 800	1 900
5320-C	100	3.7370	215	9.8425	82.6	3.2520	2.5	.10	255 000	57 300	255 000	57 300	1 800	2 600	1 800
5322-C	110	4.3307	240	9.4488	92.1	3.6260	2.5	.10	291 000	65 400	305 000	68 600	1 700	2 400	1 700

¹⁾ Fillet radius indicates maximum fillet radius on shaft or in housing which bearing corner will clear.

²⁾ Listed values are for pressed steel cage, ABEC-1.

The values have been determined through historical application and practice. For a more complete explanation, see page 276.

³⁾ Rating for one million revolutions or 500 hours at 33 1/3 RPM.

Note: Extra width bearings identified by the suffix C1 are supplied with a retrofit kit described on pages 147, 148.

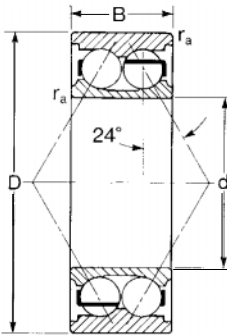

5400 Series bearings are used with extremely heavy radial loads, two-directional thrust loads, or a combination of both.

5406-5414 have a 24° contact angle per row.

5415-5418 have a zero degree contact angle.

MRC Bearing Number	Bore d		Outside Diameter D		Width B		Fillet Radius ¹⁾ r _a	Basic Radial Load Rating				Speed Rating ²⁾		
								Dynamic C ³⁾		Static C ₀		Grease RPM	Oil RPM	
								N	lbf	N	lbf			
5406C	30	1.1811	90	3.5433	39.7	1.5630	1.5	.06	67 600	15 200	45 000	10 100	5 300	7 000
5407C	35	1.3780	100	3.9370	44.4	1.7480	1.5	.06	76 100	17 000	49 000	11 000	4 800	6 300
5408C	40	1.5748	110	4.3307	49.2	1.9370	2.0	.08	88 400	19 900	57 000	12 800	4 300	5 600
5409C	45	1.7717	120	4.7244	54.0	2.1260	2.0	.08	112 000	25 200	78 000	17 600	4 000	5 300
5410C	50	1.9685	130	5.1181	58.7	2.3110	2.0	.08	143 000	32 200	102 000	23 000	3 600	4 800
5411C	55	2.1654	140	5.5118	63.5	2.5000	2.0	.08	146 000	32 900	102 000	23 000	3 200	4 300
5412C	60	2.3622	150	5.9055	66.7	2.6260	2.0	.08	159 000	35 800	114 000	25 700	3 000	4 000
5413C	65	2.5591	160	6.2992	71.4	2.8110	2.0	.08	195 000	43 900	156 000	35 100	2 800	3 800
5414C	70	2.7559	180	7.0866	79.4	3.1260	2.5	.10	199 000	44 800	156 000	35 100	2 400	3 400
5415C	75	2.9528	190	7.4803	82.6	3.2520	2.5	.10	212 000	47 700	200 000	45 000	2 200	3 200
5416C	80	3.1496	200	7.8740	87.3	3.4370	2.5	.10	229 000	51 500	216 000	48 600	2 000	3 000
5417C	85	3.3465	210	8.2677	92.1	3.6260	3.0	.12	255 000	57 300	255 000	57 300	1 900	2 800
5418C	90	3.5433	225	8.8583	98.4	3.8740	3.0	.12	281 000	63 200	300 000	67 400	1 800	2 600

¹⁾ Fillet radius indicates maximum fillet radius on shaft or in housing which bearing corner will clear.

²⁾ Listed values are for pressed steel cage, ABEC-1.

The values have been determined through historical application and practice. For a more complete explanation, see page 276.

³⁾ Rating for one million revolutions or 500 hours at 33 1/3 RPM.

Dynamic equivalent radial load and life calculation examples

Bearing size: 5210 M
 Speed: 2000 RPM
 Basic dynamic radial load rating (C) = 12100 lbf

Bearing size: 5203 SB
 Speed: 2000 RPM
 Basic dynamic radial load rating (C) = 3330

Case 1

Radial load (F_R) = 1750
 $F_A/F_R = 0/1750 = 0$
 Equivalent load (P) = $X F_R + Y F_A$
 Since $F_A/F_R < e$, equivalent load (P) =
 $1.0 F_R + 0.78 F_A = 1.0 \times 1750 = 1750$
 Life (L10) = $\left(\frac{C}{P}\right)^3 = \left(\frac{12100}{1750}\right)^3 = 331 \times 10^6$ Rev.
 or
 Life (L10h) = $\frac{10^6}{60n} \left(\frac{C}{P}\right)^3 = \frac{10^6}{60 \times 2000} \left(\frac{12100}{1750}\right)^3$
 = 2755 Hrs

Case 1

Radial load (F_R) = 500
 $F_A/F_R = 0/500 = 0$
 Equivalent load (P) = $X F_R + Y F_A$
 Since $F_A/F_R < e$, equivalent load (P) =
 $1.0 F_R + 0.78 F_A = 1.0 \times 500 = 500$
 Life (L10) = $\left(\frac{C}{P}\right)^3 = \left(\frac{3330}{500}\right)^3 = 295 \times 10^6$ Rev.
 or
 Life (L10h) = $\frac{10^6}{60n} \left(\frac{C}{P}\right)^3 = \frac{10^6}{60 \times 2000} \left(\frac{3330}{500}\right)^3$
 = 2462 Hrs

Case 2

Radial load (F_R) = 1750
 Thrust load (F_A) = 1300
 $F_A/F_R = 1300/1750 = 0.74$
 Equivalent load (P) = $X F_R + Y F_A$
 Since $F_A/F_R < e$, equivalent load (P) =
 $1.0 F_R + 0.78 F_A = 1.0 \times 1750 + 0.78 \times 1300 = 2764$
 Life (L10) = $\left(\frac{C}{P}\right)^3 = \left(\frac{12100}{2764}\right)^3 = 83.9 \times 10^6$ Rev.
 or
 Life (L10h) = $\frac{10^6}{60n} \left(\frac{C}{P}\right)^3 = \frac{10^6}{60 \times 2000} \left(\frac{12100}{2764}\right)^3$
 = 699 Hrs

Case 2

Radial load (F_R) = 500
 Thrust load (F_A) = 325
 $F_A/F_R = 325/500 = 0.65$
 Equivalent load (P) = $X F_R + Y F_A$
 Since $F_A/F_R < e$, equivalent load (P) =
 $1.0 F_R + 0.92 F_A = 1.0 \times 500 + 0.792 \times 1325 = 799$
 Life (L10) = $\left(\frac{C}{P}\right)^3 = \left(\frac{3330}{799}\right)^3 = 72.4 \times 10^6$ Rev.
 or
 Life (L10h) = $\frac{10^6}{60n} \left(\frac{C}{P}\right)^3 = \frac{10^6}{60 \times 2000} \left(\frac{3330}{799}\right)^3$
 = 603 Hrs

Case 3

Radial load (F_R) = 1750
 Thrust load (F_A) = 13500
 $F_A/F_R = 1500/1750 = 0.86$
 Equivalent load (P) = $X F_R + Y F_A$
 Since $F_A/F_R < e$, equivalent load (P) =
 $0.63 F_R + 1.24 F_A = 0.63 \times 1750 + 1.24 \times 1500$
 = 2963
 Life (L10) = $\left(\frac{C}{P}\right)^3 = \left(\frac{12100}{2963}\right)^3 = 68.1 \times 10^6$ Rev.
 or
 Life (L10h) = $\frac{10^6}{60n} \left(\frac{C}{P}\right)^3 = \frac{10^6}{60 \times 2000} \left(\frac{12100}{2963}\right)^3$
 = 568 Hrs

Case 3

Radial load (F_R) = 500
 Thrust load (F_A) = 375
 $F_A/F_R = 375/500 = 0.75$
 Equivalent load (P) = $X F_R + Y F_A$
 Since $F_A/F_R > e$, equivalent load (P) =
 $0.67 F_R + 1.41 F_A$
 = $0.67 \times 500 + 1.41 \times 375 = 864$
 Life (L10) = $\left(\frac{C}{P}\right)^3 = \left(\frac{3330}{864}\right)^3 = 57.3 \times 10^6$ Rev.
 or
 Life (L10h) = $\frac{10^6}{60n} \left(\frac{C}{P}\right)^3 = \frac{10^6}{60 \times 2000} \left(\frac{3330}{864}\right)^3$
 = 477 Hrs

Case 4

Thrust load (F_R) = 1500
 $F_A/F_R = 1500/0 = \infty$
 Equivalent load (P) = $X F_R + Y F_A$
 Since $F_A/F_R > e$, equivalent load (P) =
 $0.63 F_R + 1.24 F_A = 1.24 \times 1500 = 1860$
 Life (L10) = $\left(\frac{C}{P}\right)^3 = \left(\frac{12100}{1860}\right)^3 = 275 \times 10^6$ Rev.
 or
 Life (L10h) = $\frac{10^6}{60n} \left(\frac{C}{P}\right)^3 = \frac{10^6}{60 \times 2000} \left(\frac{12100}{1860}\right)^3$
 = 2294 Hrs

Case 4

Thrust load (F_R) = 375
 $F_A/F_R = 375/0 = \infty$
 Equivalent load (P) = $X F_R + Y F_A$
 Since $F_A/F_R > e$, equivalent load (P) =
 $0.67 F_R + 1.41 F_A = 1.41 \times 375 = 529$
 Life (L10) = $\left(\frac{C}{P}\right)^3 = \left(\frac{3330}{529}\right)^3 = 249 \times 10^6$ Rev.
 or
 Life (L10h) = $\frac{10^6}{60n} \left(\frac{C}{P}\right)^3 = \frac{10^6}{60 \times 2000} \left(\frac{3330}{529}\right)^3$
 = 2075 Hrs