

Straight Blade Devices

20A, 125V, 2 Pole, 3 Wire Grounding

SNAPConnect[®] Hospital Grade USB Charger Receptacle

HUBBELL

Features

- Fast Charge USB Ports
- Combination Ports, One Type A, One Type C
- High Power 3 Amp, up to 9 Volt USB Output
- USB Ports Rated 10,000 Cycles
- Hospital Grade Receptacle

Ordering Information

Description	Device Color	UPC Number	Catalog Number
Hospital Grade 15A 125V Duplex, Black 5 Amp USB Ports	Black	883778308611	SNAP8300UACBK

Listings

cULus Listed to UL498, UL1310

Specifications

Face	Reinforced Thermoplastic
Base	Reinforced Thermoplastic
Indicator	Green LED
Terminals	SNAPConnect
Mounting Strap	Galvanized Steel
Electrical	Certified for current interrupting at full rated current
Mounting Screws	Stainless Steel
USB Port	Stainless Steel

Performance

Electrical	
Current Interrupting	Certified for current interrupting at full rated current
Dielectric Voltage	Withstands 1,500V minimum Complies with USB BC1.2 Battery Charging and 3.0 Power Delivery Specifications

Mechanical

Product Identification	Ratings are a permanent part of the device
Terminal Accommodation	#14-#10 AWG copper stranded or solid conductor only
Terminal Identification	Terminals identified in accordance with UL 498 and CSA
USB Ports	Stainless steel rated for 10,000 plug insertions and removal

Environmental

Flammability	UL 94V-2
Operating Temperature	Maximum continuous 75°C, minimum -40°C (w/o impact)

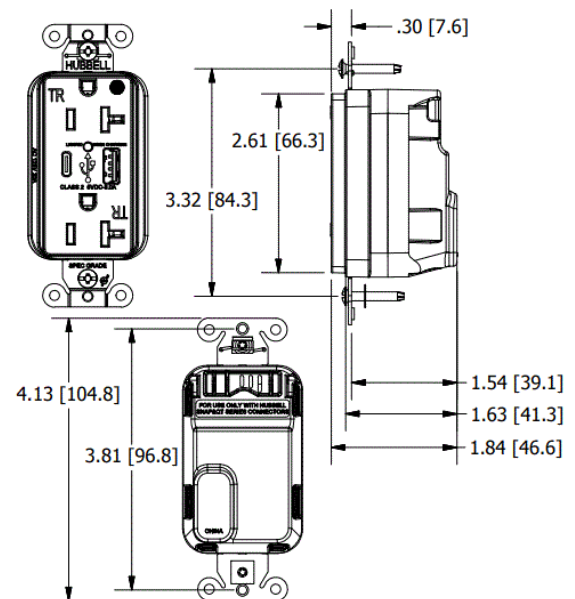

Online Resources

Customer Sales Drawing
eCatalog
Installation Instructions

Dimensions in Inches (mm)

Hubbell Wiring Device-Kellems • Hubbell Incorporated (Delaware) • 40 Waterview Drive • Shelton, CT 06484

Phone (800) 288-6000 • Fax (800) 255-1031 • Specifications subject to change without notice.

