

H-MOSS Controls Adaptive Dual Technology Wall Switch Sensor

HUBBELL

Features

- Dual technology sensing combines the individual advantages of passive infrared and ultrasonic detection
- Built in photocell with manual super saver mode for daylight harvesting
- Impact resistant hard lens is standard and color matched to the switch
- 0-10V Dimming with compatible IEC 60929 standard compliant ballasts/LED drivers



Ordering Information

Description	Color	UPC Number	Catalog Number
DualTech Wall Switch Sensor with Dimming	White	783585427867	ADD2000W1

Listings

cULus Listed
ASHRAE 90.1
CEC Title 24 Certified

Specifications

Housing	High-impact injection-molded plastic (UL-94-5V)
Lens	Impact-resistant lens
Mounting Height	42 to 54 Inches Above Floor
Sensing	Passive Infrared and Ultrasonic
Dimming	0-10V, Sink up to 30mA

Performance

Controls	On/Raise Button & Off/Lower Button
Front Press Switch	Optional Photocell, Adjustable Light Override, 10 to 500 foot candles
Ambient Light	
Timer Time Outs	Auto mode: 4-20 minutes; self-adjusts based on occupancy; fixed mode: 4, 8, 15, and 20 minutes; Test mode: 5 seconds
Electrical	
Ratings	120V AC: 800W Electronic ballast/LED driver 1,000W Magnetic ballast 277V AC: 1,200W Magnetic ballast/ Electronic ballast/LED driver

Environmental	
Operating Temperature	Indoor use only, operating temperature: 32° to 104°F (0° to 40°C), relative humidity (non-condensing): 0% to 95%

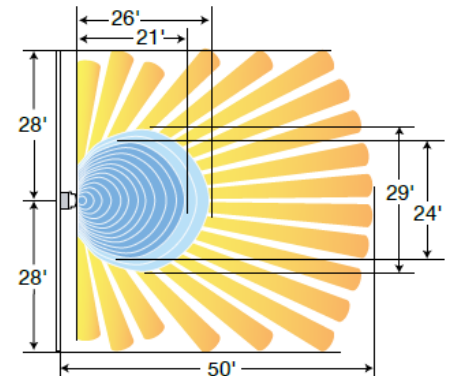
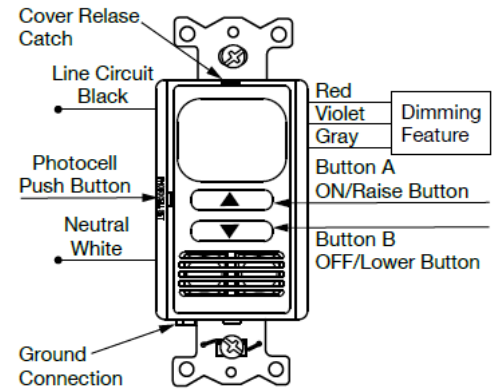

Dimensions in Inches (mm)

Hubbell Wiring Device-Kellems • Hubbell Incorporated (Delaware) • 40 Waterview Drive • Shelton, CT 06484

Phone (800) 288-6000 • Fax (800) 255-1031 • Specifications subject to change without notice.

